

# HF05

## Industrial heat flux sensor

*HF05 measures heat flux and surface temperature in industrial environments. The sensor has a fully sealed stainless steel body and a PTFE cable. It can withstand relatively extreme environmental conditions.*



**Figure 1** HF05 industrial heat flux sensor



**Figure 2** Example of an industrial heat flux sensor mounted on a boiler wall using tack-welded threads and spring-loaded bolts. The sensor is mounted on a well-prepared flat surface. Cabling must be provided with strain relief.

### Introduction

HF05 measures heat flux through the object on which it is mounted, in  $W/m^2$ , as well as its surface temperature in  $^{\circ}C$ . The sensors in HF05 are a thermopile and a type K thermocouple. A thermopile and a thermocouple are passive sensors; they do not require power. The sensors inside HF05 are protected by a fully sealed stainless steel body. Typical applications of HF05 are studies of fouling in industrial environments mounted on tubing or on the jacket of reactors. HF05 is also used for performance evaluation of industrial insulation. Using HF05 is easy. It can be connected directly to commonly used data logging systems. The heat flux in  $W/m^2$  is calculated by dividing the HF05 output, a small voltage, by the sensitivity. The sensitivity is provided with HF05 on its product certificate.

### Standards

HF05 complies with the requirements of ASTM C1041-85 (2007) Standard Practice for In-Situ Measurements of Heat Flux in Industrial Thermal Insulation Using Heat Flux Transducers.

### Calibration

HF05 calibration is traceable to international standards. The factory calibration method follows the recommended practice of ASTM C1130.

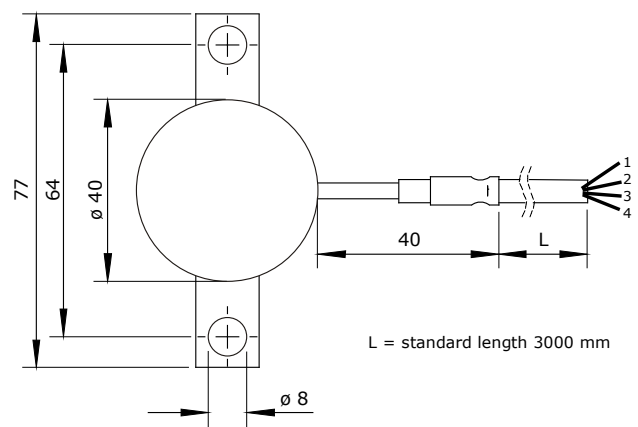

**Figure 3** HF05 dimensions in  $\times 10^{-3}$  m.

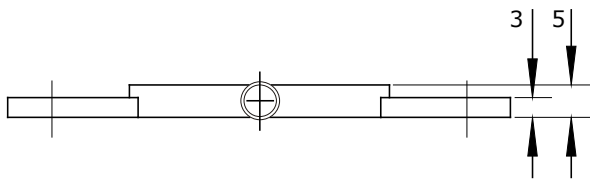

**Figure 4** HF05 dimensions in  $\times 10^{-3}$  m.

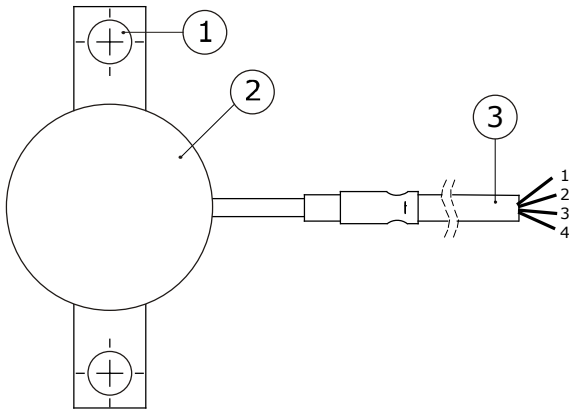

**Figure 5** HF05: The heat flux sensor (2) is connected to a short rigid stainless steel tube. This sensor-to-cable transition is connected to a PTFE cable (3). Two mounting flanges (1) are attached to the sensor body.

### Suggested use

- industrial heat flux measurements
- performance evaluation of industrial insulation

### See also

- models [IHF01](#) and [IHF02](#) for higher temperatures up to 900 °C
- model [HFP01](#) for lower temperatures up to 70 °C
- our complete [product range of heat flux sensors](#)
- [our industrial heat flux sensors \(PDF\)](#)

### HF05 specifications

Measurand	heat flux
Measurand	temperature
Heat flux sensor	thermopile
Temperature sensor	thermocouple type K
Uncertainty of heat flux calibration	$\pm 10\%$ ( $k=2$ )
Calibration traceability	to SI units
Recommended number of sensors	2 per measurement location
IP protection class	IP67
Measurement range	-6000 to 6000 W/m <sup>2</sup>
Sensitivity (nominal)	$15 \times 10^{-6}$ V/(W/m <sup>2</sup> )
Rated operating temperature range	-30 to +170 °C
Standard cable length	3 m
Order code	HF05 / cable length in m

### Options

- longer cable (specify total cable length in m)
- connector at HF05 cable end
- EC type examination certificate (ATEX) II 2G Ex db IIC T6
- extension cable with 2 connectors matching cable connector and chassis connector (specify cable length in m)
- chassis connector with internal wiring (colour code of wiring identical to cable colour code)

### About Hukseflux

Hukseflux Thermal Sensors makes sensors and measuring systems. Our aim is to let our customers work with the best possible data. Many of our products are used in support of energy transition and efficient use of energy. We also provide services: calibration and material characterisation. Our main area of expertise is measurement of heat transfer and thermal quantities such as solar radiation, heat flux and thermal conductivity. Hukseflux is ISO 9001 certified. Hukseflux products and services are offered worldwide via our office in Delft, the Netherlands and local distributors.

Interested in this product?  
E-mail us at: [info@hukseflux.com](mailto:info@hukseflux.com)

# HF05 outperforms competing models: how?

The HF05 industrial heat flux sensor is ideal for medium temperature applications. This is why.

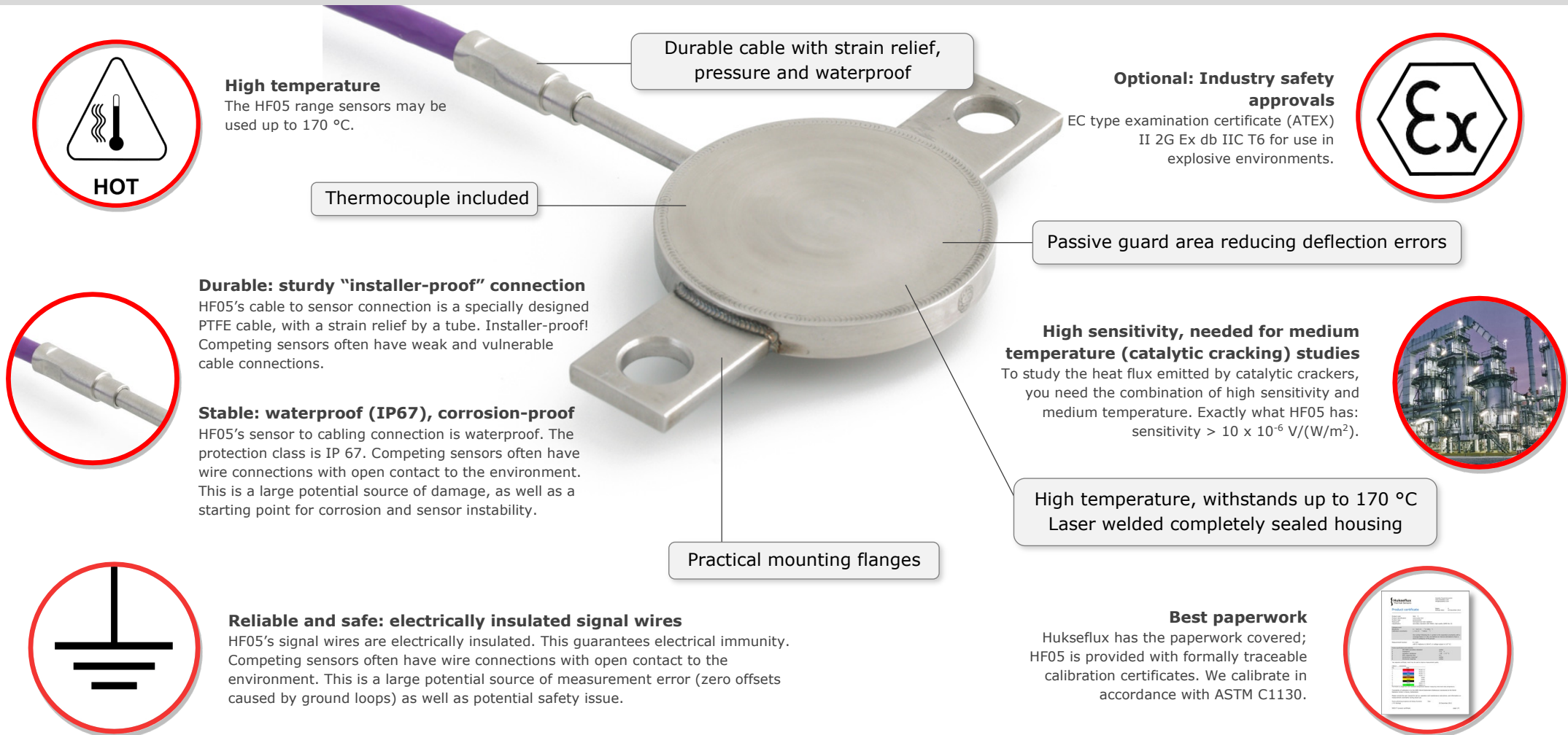



**HOT**

**High temperature**  
The HF05 range sensors may be used up to 170 °C.

Durable cable with strain relief, pressure and waterproof

**Optional: Industry safety approvals**  
EC type examination certificate (ATEX) II 2G Ex db IIC T6 for use in explosive environments.



Thermocouple included

Passive guard area reducing deflection errors



**Durable: sturdy "installer-proof" connection**  
HF05's cable to sensor connection is a specially designed PTFE cable, with a strain relief by a tube. Installer-proof! Competing sensors often have weak and vulnerable cable connections.

**High sensitivity, needed for medium temperature (catalytic cracking) studies**  
To study the heat flux emitted by catalytic crackers, you need the combination of high sensitivity and medium temperature. Exactly what HF05 has: sensitivity > 10 x 10<sup>-6</sup> V/(W/m<sup>2</sup>).



**Stable: waterproof (IP67), corrosion-proof**  
HF05's sensor to cabling connection is waterproof. The protection class is IP 67. Competing sensors often have wire connections with open contact to the environment. This is a large potential source of damage, as well as a starting point for corrosion and sensor instability.

High temperature, withstands up to 170 °C  
Laser welded completely sealed housing

Practical mounting flanges

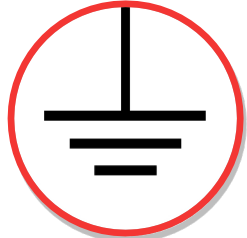

**Reliable and safe: electrically insulated signal wires**  
HF05's signal wires are electrically insulated. This guarantees electrical immunity. Competing sensors often have wire connections with open contact to the environment. This is a large potential source of measurement error (zero offsets caused by ground loops) as well as potential safety issue.

**Best paperwork**  
Hukseflux has the paperwork covered; HF05 is provided with formally traceable calibration certificates. We calibrate in accordance with ASTM C1130.

